



Llaves fijas de dos bocas abiertas

pg.



66

Llave fija de golpe



68

Llaves combinadas



69

Llave de estrella plana de impacto



70

Llaves de estrella acodada

pg.



72

Llaves de estrella plana



75

Llaves acodadas con carraca



76

Llaves combinadas con carraca



77

Llaves de tubo

pg.



80

Llaves de pipa



82

Llaves de ruedas



83

Llaves de vaso articuladas



84

Llaves de vaso mango en T

pg.



85

Llaves de cabina



85

Llaves articuladas



86

Llaves de fleje



86

Llaves ajustables moleta lateral

pg.



87

Llaves ajustables



88

Llaves dinamométricas



89

Llaves fijas

110

UNE 16521
DIN 3110Fabricada en Acero
al Cromo-VanadioPresentación
satinado mateBocas con chafflán
para un fácil
encaje en la tuerca

Cabezas pulidas

Fabricada según
normas DINAcodado de 30° para
acceso a lugares difíciles

Code	Hex	L [mm]	E [mm]	P.V.P. unid. €	Image
191004	4x5	105	3,2	2,99	10
191005	6x7	122	3.2	3,10	10
191010	8x9	140	3.5	3,23	10
191015	10x11	156	4.5	3,38	10
191012	10x13	172	5.1	3,99	10
191020	12x13	172	5	4,15	10
191028	13x17	188	5.6	5,14	10
191025	14x15	188	5.5	4,41	10
191030	16x17	204	6	5,22	10
191033	17x19	220	6.5	5,65	10
191035	18x19	220	6.5	5,72	5
191038	19x22	234	7.2	6,70	5
191040	20x22	234	7.5	6,70	5

Code	Hex	L [mm]	E [mm]	P.V.P. unid. €	Image
191045	21x23	247	7.5	7,24	5
191047	22x24	247	7.5	7,42	5
191050	24x26	266	8.5	8,51	5
191055	24x27	266	8.5	8,51	5
191060	25x28	285	8.5	9,68	5
191065	27x29	300	9.5	11,21	5
191070	30x32	302	9.5	13,15	5
191072	32x36	320	10	21,70	5
191073	34x36	320	10	22,77	5
191075	36x41	380	12.2	25,38	4
191076	41x46	415	14.7	37,60	2
191077	46x50	465	15.7	47,00	2

Juego de Llaves fijas, caja cartón

110JC

6 Llaves



Code	Nº Piezas	P.V.P. unid. €	Image
191082	6	26,12	2

COMPOSICIÓN 8x9, 10x11, 12x13, 14x15, 16x17, 18x19 mm

110JC

8 Llaves



Code	Nº Piezas	P.V.P. unid. €	Image
191080	8	34,94	2

COMPOSICIÓN 6x7, 8x9, 10x11, 12x13, 14x15, 16x17, 18x19, 20x22 mm

Juego de Llaves fijas, bolsa de nylon

110JN

8 Llaves



Code	Nº Piezas	P.V.P. unid. €	
191081	8	35,38	2

COMPOSICIÓN 6x7, 8x9, 10x11, 12x13, 14x15, 16x17, 18x19, 20x22 mm

110JN

12 Llaves



Code	Nº Piezas	P.V.P. unid. €	
191086	12	76,81	2

COMPOSICIÓN 6x7, 8x9, 10x11, 12x13, 14x15, 16x17, 18x19, 20x22, 21x23, 24x27, 25x28, 30x32 mm

Juego de Llaves fijas, soporte plástico

110JH

8 Llaves



Tapa de plástico que se puede abrir o cerrar mediante clip

Code	Nº Piezas	P.V.P. unid. €	
191090	8	35,90	2

COMPOSICIÓN 6x7, 8x9, 10x11, 12x13, 14x15, 16x17, 18x19, 20x22 mm

110J

12 Llaves



Code	Nº Piezas	P.V.P. unid. €	
191085	12	74,52	2

COMPOSICIÓN 6x7, 8x9, 10x11, 12x13, 14x15, 16x17, 18x19, 20x22, 21x23, 24x27, 25x28, 30x32 mm

Juego de Llaves fijas, caja plástica

110JP

8 Llaves

Medida caja: 255x185x48 mm

Code	Nº Piezas	P.V.P. unid. €	
191096	8	36,81	2

COMPOSICIÓN 6x7, 8x9, 10x11, 12x13, 14x15, 16x17, 18x19, 20x22 mm



Llaves fijas - pulgadas

110P

DIN 3110



Acodado de 30°
para acceso a
lugares difíciles

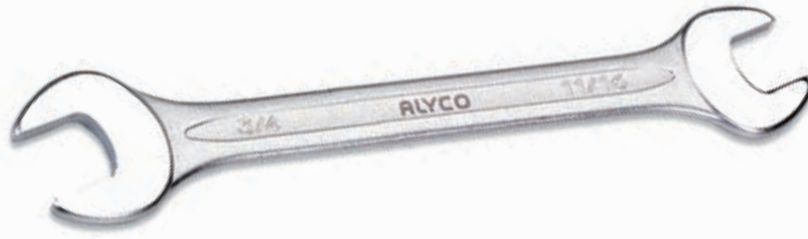

Code	Hex	L ←mm→	E ←mm→	P.V.P. unid. €	
190002	1/4"x5/16"	122	3,3	3,10	1
190004	5/16"x3/8"	140	3,6	3,23	1
190006	3/8"x7/16"	156	4,6	3,38	1
190008	7/16"x1/2"	172	5,1	4,15	1
190010	1/2"x9/16"	180	5,1	4,41	1
190012	9/16"x5/8"	188	5,6	4,65	1
190014	5/8"x11/16"	204	6,1	5,22	1
190016	11/16"x3/4"	220	6,5	5,72	1

Code	Hex	L ←mm→	E ←mm→	P.V.P. unid. €	
190018	3/4"x7/8"	234	7,2	6,06	1
190020	13/16"x7/8"	247	7,5	7,25	1
190022	15/16"x1"	266	8,2	8,51	1
190024	1"x1-1/8"	285	8,4	9,68	1
190026	1-1/8"x1-5/16"	302	9,1	13,15	1
190028	1-1/16"x1-1/4"	302	9,1	13,15	1
190030	1-7/16"x1-5/8"	380	12,2	25,34	1

Juego de Llaves fijas, bolsa de nylon - pulgadas

110P-JP

8 Llaves



Code	Nº Piezas	P.V.P. unid. €	
190040	8	35,77	1

COMPOSICIÓN 1/4"x5/16" • 5/16"x3/8" • 3/8"x7/16" • 1/2"x9/16"
9/16"x5/8" • 5/8"x11/16" • 11/16"x3/4" • 3/4"x7/8"

110P-JP

12 Llaves



Code	Nº Piezas	P.V.P. unid. €	
190045	12	74,37	1

COMPOSICIÓN 1/4"x5/16" • 5/16"x3/8" • 3/8"x7/16" • 1/2"x9/16"
9/16"x5/8" • 5/8"x11/16" • 11/16"x3/4" • 3/4"x7/8" • 13/16"x7/8"
15/16"x1" • 1"x1-1/8" • 1-1/16"x1-1/4"

Llave fija de golpe

110IMP

DIN 3110

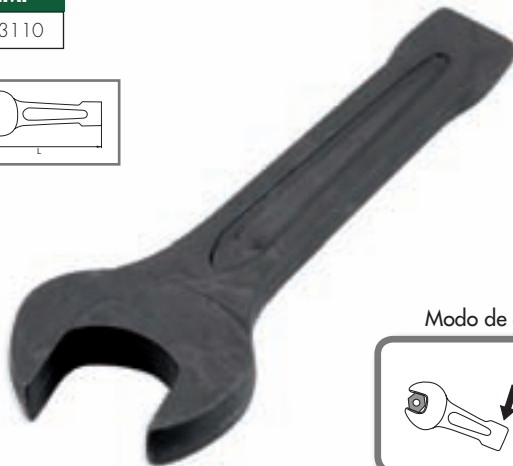
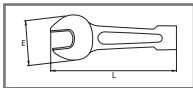

Modo de empleo

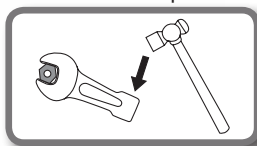

Code	Hex mm	L ←mm→	E ←mm→	P.V.P. unid. €	
190824	24	177	52,5	17,05	1
190827	27	180	56	18,84	1
190830	30	190	62	22,06	1
190832	32	190	62	23,98	1
190836	36	215	74	27,97	1
190838	38	215	74	34,10	1
190841	41	235	86	37,10	1
190846	46	255	96	41,10	1
190850	50	275	105	48,40	1
190855	55	300	115	60,40	1
190860	60	320	126	70,94	1
190865	65	343	138	82,55	1
190870	70	375	154	108,85	1
190875	75	375	154	112,40	1
190880	80	400	174	146,41	1
190885	85	400	174	184,62	1

- Fabricada en Acero al Cromo-Vanadio
- Acabado pavonado

Llaves combinadas

121

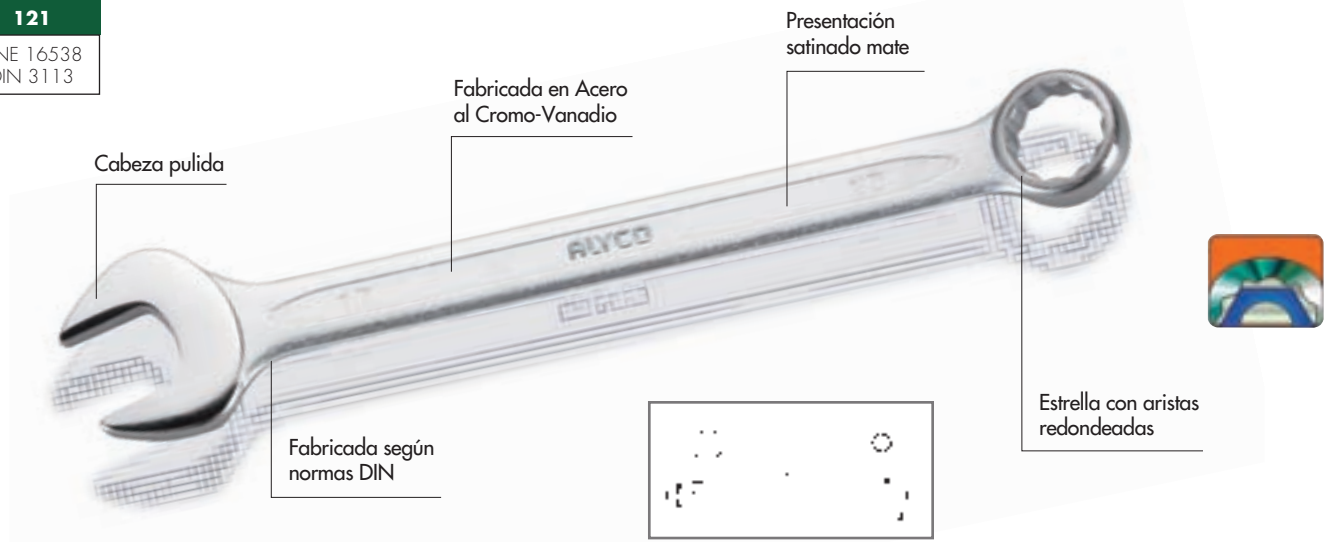
 UNE 16538
 DIN 3113

Code	⊕	L ←mm→	E ←mm→	E1 ←mm→	P.V.P. unid. €	
191203	6	110	3.6	5	4,08	10
191206	7	110	3.6	5.5	4,14	10
191209	8	120	4.1	6	4,19	10
191212	9	130	4.1	6.5	4,90	10
191215	10	140	4.6	7	4,95	10
191218	11	150	5	7	5,43	10
191221	12	160	5.1	7.5	5,72	10
191224	13	170	5.5	8	6,08	10
191227	14	180	5.8	8.5	6,27	5
191230	15	190	6	9	6,49	5
191233	16	200	6.2	9.5	6,94	5
191236	17	210	6.5	10	7,41	5
191239	18	220	6.7	10.5	7,83	5
191242	19	230	7.3	11	8,86	5
191245	20	240	7.5	11.5	9,01	5
191248	21	250	7.8	12	10,20	5

Code	⊕	L ←mm→	E ←mm→	E1 ←mm→	P.V.P. unid. €	
191251	22	260	8	12.5	10,35	5
191254	23	260	8	12.5	11,04	5
191257	24	280	8.5	13.5	11,52	5
191260	25	295	8.8	14	12,41	5
191263	26	295	8.8	14	15,13	5
191266	27	310	9	15	16,32	5
191269	28	340	9.5	16.5	17,37	5
191272	29	340	9.5	16.5	17,53	5
191275	30	340	9.5	16.5	17,78	5
191278	32	360	9.7	17.5	19,90	5
191279	34	380	11.5	18	22,42	3
191281	36	410	13	18.2	33,01	3
191282	41	460	15.5	20	41,02	3
191283	46	500	16.2	21	52,39	3
191284	50	540	17.2	22.6	60,82	3

Juego de Llaves combinadas, bolsa de nylon

121JN

26 Llaves



Code	Nº Piezas	P.V.P. unid. €	
191286	26	256,25	1

COMPOSICIÓN todas las medidas entre 6 y 32 mm

Juego Llaves combinadas, caja cartón

121JC

8 Llaves



Code	Nº Piezas	P.V.P. unid. €	
191280	8	52,73	2

COMPOSICIÓN 8, 10, 11, 12, 13, 14, 17, 19 mm

Juego Llaves combinadas, soporte plástico

121JH

8 Llaves



Code	Nº Piezas	P.V.P. unid. €	
191290	8	53,72	2

COMPOSICIÓN 8, 10, 11, 12, 13, 14, 17, 19 mm

Juego Llaves combinadas, soporte plástico

121JH

12 Llaves



Code	Nº Piezas	P.V.P. unid. €	
191285	12	77,70	2

COMPOSICIÓN 8, 9, 10, 11, 12, 13, 14, 15, 16, 17, 18, 19 mm

Juego Llaves combinadas, caja plástico

121JP

8 Llaves



Medida caja: 255x185x48 mm

Code	Nº Piezas	P.V.P. unid. €	
191296	8	53,29	2

COMPOSICIÓN 8, 10, 11, 12, 13, 14, 17, 19 mm

Llave de estrella plana de impacto



207IMP

- Fabricada en Acero al Cromo-Vanadio
- Estrella 12 puntas con aristas redondeadas
- Acabado pavonado

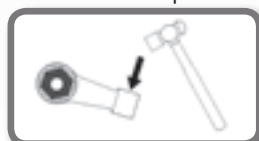

Modo de empleo



Code		L ←mm→	D ←mm→	E ←mm→	P.V.P. unid. €	
191370	24	168	43,4	14,8	17,99	1
191371	27	180	46	16	19,90	1
191372	30	190	51,5	17	23,58	1
191373	32	190	54	17	25,35	1
191374	36	205	58,5	18,5	29,28	1
191375	38	228	64,6	20,1	36,26	1
191376	41	230	65	20	39,80	1
191377	46	240	73,5	22	43,42	1
191378	50	253	78,5	24	51,40	1
191379	55	266	85	25	64,19	1
191381	60	280	92	26	75,17	1
191382	65	300	102	30	88,25	1
191383	70	330	110	33	115,21	1
191384	75	330	110	33	119,13	1
191385	80	340	118	34	156,87	1
191386	85	355	130	36	194,80	1
191387	90	390	142	39	234,74	1
191388	95	390	142	39	250,92	1
191389	100	420	155	43	301,00	1

Llaves combinadas - pulgadas

121P

DIN 3113

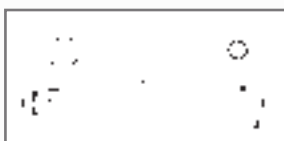

Code	⚙	L mm	E mm	E1 mm	P.V.P. unid. €	
190100	1/4"	100	3,7	4,5	4,08	1
190102	5/16"	120	4,1	5,5	4,19	1
190104	11/32"	130	4,1	6	4,91	1
190106	3/8"	140	4,6	6,5	4,95	1
190108	7/16"	150	4,7	6,5	5,43	1
190110	1/2"	170	5,5	7,5	6,08	1
190112	9/16"	180	5,6	8	6,27	1
190114	5/8"	200	5,8	9	6,94	1
190116	11/16"	210	6,3	9,5	7,83	1
190118	3/4"	230	7,1	10,4	8,86	1
190120	13/16"	250	7,5	11,4	10,20	1
190122	7/8"	260	8	11,9	10,35	1
190124	15/16"	280	8,2	12,9	11,52	1
190126	1"	295	8,7	13,4	12,41	1
190128	1-1/16"	310	8,9	14,4	16,32	1
190130	1-1/8"	340	10	15,9	17,37	1
190132	1-1/4"	360	10,8	16,9	19,90	1

Juego Llaves combinadas en bolsa de nylon - pulgadas

121P-JN

8 Llaves



Code	Nº Piezas	P.V.P. unid. €	
190140	8	45,78	1

COMPOSICIÓN 1/4" • 5/16" • 3/8" • 7/16" • 1/2" • 9/16" • 5/8" • 11/16"



121P-JN

12 Llaves



Code	Nº Piezas	P.V.P. unid. €	
190145	12	107,16	1

COMPOSICIÓN 3/8" • 7/16" • 1/2" • 9/16" • 5/8" • 11/16" • 3/4" • 13/16" • 7/8" • 15/16" • 1" • 1-1/16"



Llaves de estrella acodadas

180

UNE 16522
DIN 838

Code	Hex	L mm	E mm	E1 mm	P.V.P. unid. €	
191105	6x7	170	5.5	6.2	5,90	10
191110	8x9	182	6.5	7.4	6,45	10
191115	10x11	197	8	8.5	6,89	10
191120	12x13	212	9	9.5	7,28	10
191128	13x17	245	9	11	9,17	10
191125	14x15	227	10	10.5	7,90	10
191130	16x17	245	11	11.5	9,39	10
191133	17x19	265	11.4	11.9	10,77	10
191135	18x19	265	12	12.5	10,85	10
191138	19x22	288	12.4	12.9	12,52	5
191140	20x22	287	13	13.5	12,52	5

Code	Hex	L mm	E mm	E1 mm	P.V.P. unid. €	
191145	21x23	310	13	14	14,13	5
191148	22x24	310	13	14	14,51	5
191150	24x26	330	14.5	15	17,55	5
191155	24x27	330	14.5	15	17,55	5
191160	25x28	350	15	15.5	20,38	5
191165	27x29	360	16	16.5	21,63	5
191170	30x32	372	16	17	24,68	5
191172	32x36	415	16.5	17.8	36,07	2
191175	36x41	460	17.3	19.2	43,07	2
191177	46x50	526	20	22.5	70,09	2

Juego de Llaves acodadas, bolsa de nylon

180JN

12 Llaves



Code	Nº Piezas	P.V.P. unid. €	
191185	12	144,02	1

COMPOSICIÓN 6x7, 8x9, 10x11, 12x13, 14x15, 16x17, 18x19, 20x22, 21x23, 24x27, 25x28, 30x32 mm

Juego de Llaves acodadas, caja cartón

180JC

6 Llaves



Code	Nº Piezas	P.V.P. unid. €	
191182	6	48,75	2

COMPOSICIÓN 8x9, 10x11, 12x13, 14x15, 16x17, 18x19 mm

180JC

8 Llaves



Code	Nº Piezas	P.V.P. unid. €	
191180	8	67,19	2

COMPOSICIÓN 6x7, 8x9, 10x11, 12x13, 14x15, 16x17, 18x19, 20x22 mm

Juego de Llaves acodadas, bolsa de nylon

180JN

8 Llaves



Code	Nº Piezas	P.V.P. unid. €	
191181	8	67,51	2

COMPOSICIÓN 6x7, 8x9, 10x11, 12x13, 14x15, 16x17, 18x19, 20x22 mm

Juego de Llaves acodadas, soporte plástico

180JH

8 Llaves



Code	Nº Piezas	P.V.P. unid. €	
191190	8	67,60	2

COMPOSICIÓN 6x7, 8x9, 10x11, 12x13, 14x15, 16x17, 18x19, 20x22 mm

Juego de Llaves acodadas, caja plástico

180JP

7 Llaves

Medida caja: 255x185x48 mm

Code	Nº Piezas	P.V.P. unid. €	
191196	7	54,66	2

COMPOSICIÓN 6x7, 8x9, 10x11, 12x13, 14x15, 16x17, 18x19 mm



Llaves de estrella acodadas - pulgadas



180P
DIN 838



Code		L mm	E mm	E1 mm	P.V.P. unid. €	
190050	1/4"x5/16"	170	4,9	5,6	5,90	1
190052	5/16"x3/8"	190	6	7,4	6,45	1
190054	3/8"x7/16"	197	7,4	7,9	6,89	1
190056	7/16"x1/2"	213	8,4	8,9	7,28	1
190058	1/2"x9/16"	228	9,4	9,9	7,90	1
190060	9/16"x5/8"	246	10,4	10,9	8,82	1
190062	5/8"x11/16"	246	10,4	10,9	9,39	1
190064	11/16"x3/4"	265	11,4	11,9	10,85	1
190066	3/4"x7/8"	288	12,4	12,9	11,79	1
190068	13/16"x7/8"	288	12,4	12,9	12,51	1
190070	13/16"x15/16"	310	13,1	13,7	14,13	1
190072	15/16"x1"	330	13,7	14,3	17,55	1
190074	1"x1-1/8"	348	14,2	14,7	20,38	1
190076	1-1/16"x1-1/4"	372	15	16	21,63	1
190078	1-1/8"x1-1/4"	372	14,8	15,8	22,50	1

Juego de Llaves acodadas, bolsa de nylon - pulgadas



180P-JN
8 Llaves



Code	Nº Piezas	P.V.P. unid. €	
190090	8	66,45	1

COMPOSICIÓN 1/4"x5/16" • 5/16"x3/8" • 3/8"x7/16" • 7/16"x1/2" • 1/2"x9/16" • 5/8"x11/16" • 3/4"x7/8" • 11/16"x3/4"



180P-JN
12 Llaves



Code	Nº Piezas	P.V.P. unid. €	
190095	12	138,61	1

COMPOSICIÓN 1/4"x5/16" • 5/16"x3/8" • 3/8"x7/16" • 7/16"x1/2" • 1/2"x9/16" • 9/16"x5/8" • 5/8"x11/16" • 3/4"x7/8" • 13/16"x7/8" • 15/16"x1" • 1-1/16"x1-1/4" • 1-1/8"x1-1/4"



Llaves de estrella planas

207

UNE 16545
DIN 837



Presentación Satinado mate

Fabricada en Acero al Cromo-Vanadio

Bocas pulidas

Estrella con aristas redondeadas

Code	mm	L mm	P.V.P. unid. €	
191305	6x7	120	5,05	10
191310	8x9	135	5,59	10
191315	10x11	155	5,71	10
191320	12x13	165	6,20	10
191325	14x15	180	6,90	10
191330	16x17	210	7,78	10
191335	18x19	225	8,51	10
191340	20x22	240	10,09	5
191345	21x23	255	12,04	5
191350	24x26	270	13,23	5
191355	25x28	280	14,82	5
191357	27x29	310	16,04	5
191360	30x32	330	17,23	5

Juego de Llaves de estrella planas

207JP

8 Llaves

Code	Nº Piezas	P.V.P. unid. €	
191396	8	55,82	2

COMPOSICIÓN 6x7, 8x9, 10x11, 12x13, 14x15, 16x17, 18x19, 20x22 mm



Juego de Llaves de estrella planas en bolsa de nylon

207JN

12 Llaves



Code	Nº Piezas	P.V.P. unid. €	
191397	12	113,15	1

COMPOSICIÓN 6x7, 8x9, 10x11, 12x13, 14x15, 16x17, 18x19, 20x22, 21x23, 24x26, 25x28, 30x32 mm



LLAVES ACODADAS CON CARRACA REVERSIBLE



117



Sistema de carraca que permite trabajar a lo largo de los espárragos y varillas roscadas sin necesidad de retirar la llave.

Carraca de 72 dientes



Terminación satinado mate

Fabricado en Acero al Cromo-Vanadio

Ambas bocas acodadas y reversibles

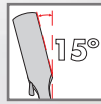

Acodado de 15° en la cabeza

Posibilidad de utilizar adaptadores

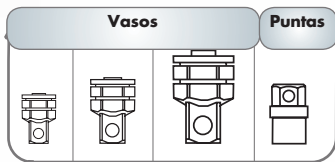

1/4" 3/8" 1/2" 1/4" Ver página 79

Code	mm	L mm	P.V.P. unid. €	
191600	8x9	128	14,98	5
191605	10x11	150	16,05	5
191610	12x13	170	17,04	5
191615	14x15	190	18,74	5
191620	16x18	230	21,44	5
191625	17x19	230	23,30	5

Juego de Llaves acodadas con carraca, caja plástico

117JP

9 piezas

Medida caja: 255x185x48 mm

Code	Nº Piezas	P.V.P. unid. €	
191650	9	111,87	1

COMPOSICIÓN 8x9, 10x11, 12x13, 14x15, 16x18, 17x19 mm.
3 adaptadores para vasos de 1/2" (191882), 1/4" (191880), 3/8" (191881)



LLAVES DE ESTRELLA ACODADAS CON TRINQUETE

208



- Llave de Trinquete Reversible.
- Terminación en satinado mate.

Code	mm	L mm	P.V.P. unid. €	
191710	7x8	108	10,67	3
191720	10x11	175	13,46	3
191730	12x13	175	17,02	3
191740	14x15	175	17,69	3
191750	16x18	203	19,13	3
191760	17x19	203	19,66	3

Llaves combinadas con carraca reversible

115

Posibilidad de utilizar adaptadores

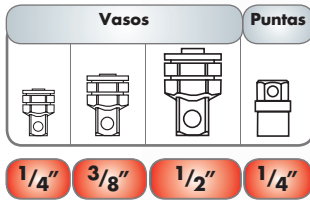

Ver página 79

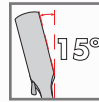

Acodado de 15° en la cabeza



Carraca Reversible

Fabricado en Acero al Cromo-Vanadio

Terminación satinado mate.
Bocas Pulidas.

Carraca de 72 dientes

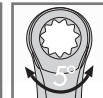

Code	mm	L mm	P.V.P. unid. €		Code	mm	L mm	P.V.P. unid. €		Code	mm	L mm	P.V.P. unid. €	
191805	8	136	12,95	5	191835	14	190	16,80	5	191862	21	284	24,04	3
191810	9	143	13,01	5	191840	15	200	17,22	5	191864	22	284	25,45	3
191815	10	159	13,07	5	191845	16	216	18,21	5	191866	24	324	28,51	3
191820	11	168	13,44	5	191850	17	233	19,14	5	191868	27	359	40,02	2
191825	12	174	14,37	5	191855	18	239	20,56	5	191870	30	425	48,87	2
191830	13	180	15,79	5	191860	19	248	21,09	5	191872	32	425	52,84	2

Juego de Llaves combinadas con carraca

115-JH

7 Llaves

En soporte de plástico de seguridad



Code	Nº Piezas	P.V.P. unid. €	
191875	7	112,27	1

COMPOSICIÓN 10, 12, 13, 14, 15, 17, 19 mm

115-JP

12 piezas

En maletín de plástico



Code	Nº Piezas	P.V.P. unid. €	
191890	12	143,03	1

COMPOSICIÓN

- 8 Llaves combinadas: 8, 10, 12, 13, 15, 17, 18, 19 mm.
- 3 Adaptadores para vasos de 1/2", 3/8", 1/4"
- 1 Adaptador para puntas de 1/4"

Llaves combinadas con carraca serie corta

115C



Diseño especial de longitud corta para trabajos en espacios muy reducidos

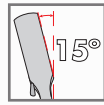

Acodado de 15° en la cabeza



Carraca Reversible

Terminación satinado mate

Bocas pulidas

Carraca de 72 dientes



Posibilidad de utilizar adaptadores

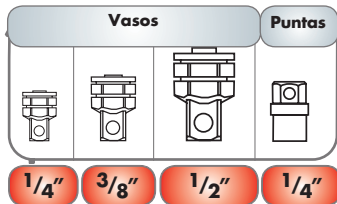

1/4" 3/8" 1/2" 1/4"

Code	mm	L mm	P.V.P. unid. €	
191955	8	90	11,70	5
191960	10	95	11,83	5
191965	13	107	14,28	5
191970	17	126	17,31	5
191975	19	138	19,08	5

Juego de llaves combinadas con carraca serie corta

115CJ

5 llaves



En soporte de plástico. Con sistema antirrobo.



Code	Nº Piezas	P.V.P. unid. €	
191980	5	74,21	1

COMPOSICIÓN 8, 10, 13, 17, 19 mm

Llave combinada flexible con carraca

116



Bocas pulidas

Fabricado en Acero al Cromo-Vanadio

Terminación satinado mate

Cabeza flexible. Posibilidad de girar la cabeza a cualquier ángulo en un intervalo de 180°

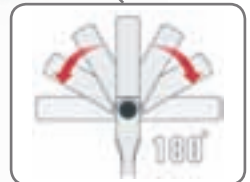

Carraca de 72 dientes



Posibilidad de utilizar adaptadores

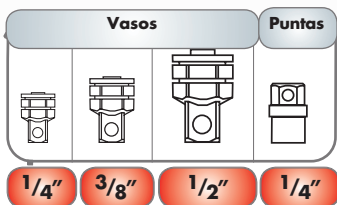

1/4" 3/8" 1/2" 1/4"

Ver página 79

Code	mm	L mm	P.V.P. unid. €	
191905	8	136	14,24	5
191910	10	159	14,39	5
191915	11	168	14,78	5
191920	12	174	15,81	5
191925	13	180	17,36	5
191930	17	233	21,06	5
191935	19	248	23,19	5

Juego de Llaves combinadas flexibles con carraca

116J

5 Llaves

En soporte de plástico. Con sistema antirrobo.



Code	Nº Piezas	P.V.P. unid. €	
191950	5	90,24	1

COMPOSICIÓN 8, 10, 13, 17, 19 mm

Llaves con carraca reversible 4 en 1



Cada boca se puede utilizar con dos medidas de tuerca diferentes

Terminación satinado mate

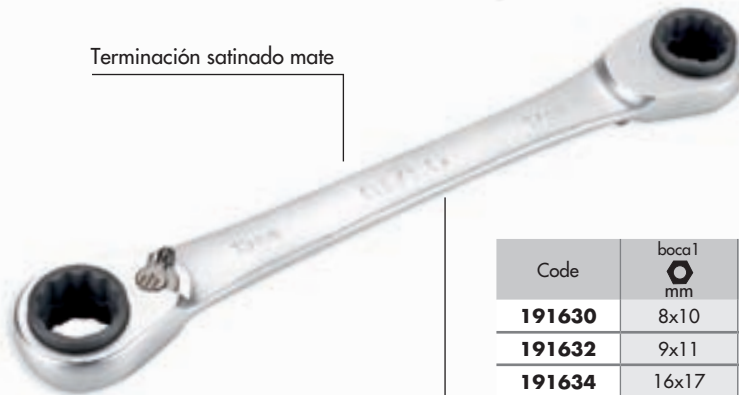

Fabricado en Acero al Cromo-Vanadio

Carraca de 72 dientes

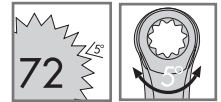

Code	boca1 mm	boca2 mm	L mm	P.V.P. unid. €	
191630	8x10	12x13	160	15,96	2
191632	9x11	14x15	180	18,67	2
191634	16x17	18x19	225	19,80	2
191636	10x13	17x19	225	19,80	2

Juego de Llaves con carraca 4 en 1, bolsa de nylon



Code	Nº Piezas	P.V.P. unid. €	
191640	3	54,95	1

COMPOSICIÓN 191630, 191632, 191634



Adaptadores para vasos y puntas

115-D



191882

191881

191880

191885

Code	Para vasos	Con Llaves	P.V.P. unid. €	
191880	1/4"	10 mm	4,17	5
191881	3/8"	13 mm	4,64	5
191882	1/2"	19 mm	5,42	5
191885	puntas 1/4"	10 mm	1,57	5

115-J

4 piezas



Code	Nº Piezas	P.V.P. unid. €	
191886	4	15,86	5

COMPOSICIÓN 191880 (1/4"), 191881 (3/8"), 191882 (1/2"), 191885 (puntas 1/4")

Cada Adaptador solo se puede acoplar en la medida de la llave que se indica en el cuadro.

Estos cuatro adaptadores son compatibles con las referencias 115-115C-116-117 (pág. 76, 77, 78, 79)

Llaves de Tubo hexagonal de doble boca forjada

194F

UNE 16586

Terminación:

- Cabezas pulidas
- Cromado satinado



Cuerpo hexagonal

Bocas forjadas

Fabricado en Acero al Cromo-Vanadio

Agujero para accionamiento con volvedor

Agujero longitudinal pasante en todas las medidas (excepto 6 x 7mm)



Code	Hex	L mm	D mm	D1 mm	P.V.P. unid. €	Icon
191405	6x7	105	10	11	7,42	10
191410	8x9	110	12.5	13.5	7,53	10
191415	10x11	120	15	16	7,94	10
191420	12x13	140	17.5	19	9,32	10
191425	14x15	145	20	21.5	10,36	10
191430	16x17	155	22.5	24	12,13	10
191435	18x19	165	25.5	26	14,55	10

Code	Hex	L mm	D mm	D1 mm	P.V.P. unid. €	Icon
191440	20x22	175	28	30	16,59	5
191445	21x23	185	29	31	18,47	5
191450	24x26	195	32.5	36.5	19,76	5
191455	25x28	205	34	37	22,17	5
191457	27x29	210	36	39	25,61	5
191460	30x32	210	40	42.5	29,10	5

Jgo. de Llaves de Tubo forjadas, en bolsa

194F-J

9 piezas

En bolsa de nylon



Code	Nº Piezas	P.V.P. unid. €	Icon
191470	9	89,76	1

COMPOSICIÓN 6x7, 8x9, 10x11, 12x13, 14x15, 16x17, 18x19, 20x22 mm + volvedor

Juego de Llaves de Tubo forjadas, sop. plástico

194F-JH

8 piezas

En soporte de plástico



Code	Nº Piezas	P.V.P. unid. €	Icon
191485	8	71,17	1

COMPOSICIÓN 6x7, 8x9, 10x11, 12x13, 14x15, 16x17, 18x19 mm + volvedor

Juego de Llaves de Tubo forjadas, en bolsa

194F-J

14 piezas

En bolsa de nylon

Code	Nº Piezas	P.V.P. unid. €	Icon
191475	14	185,22	1

COMPOSICIÓN 6x7, 8x9, 10x11, 12x13, 14x15, 16x17, 18x19, 20x22, 21x23, 24x27, 25x28, 30x32 mm + dos volvedores



Llaves de Tubo hexagonal de doble boca forjada

194F-JP

9 piezas



En caja de plástico

Medida caja: 255x185x48 mm

Code	Nº Piezas	P.V.P. unid. €	
191480	9	89,91	1

COMPOSICIÓN 6x7, 8x9, 10x11, 12x13, 14x15, 16x17, 18x19, 20x22 mm + volvedor

Llaves de Tubo redondo de doble boca estampada

194

UNE 16586

Fabricado en Tubo de Acero Cromo-Vanadio tratado

Agujero para accionamiento con volvedor

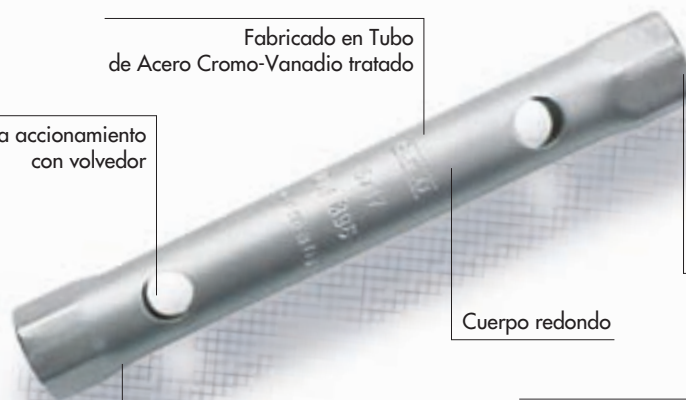

Cabeza hexagonal para accionamiento con llave

Cuerpo redondo

Presentación en satinado mate

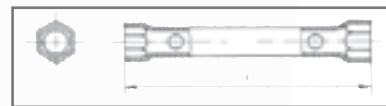

Code		L mm	P.V.P. unid. €	
191505	6x7	110	2,69	10
191510	8x9	110	2,82	10
191515	10x11	120	3,24	10
191520	12x13	140	3,86	10
191525	14x15	140	4,16	10
191530	16x17	150	4,49	10
191535	18x19	160	5,67	10

Code		L mm	P.V.P. unid. €	
191540	20x22	170	7,22	5
191545	21x23	170	7,53	5
191550	24x26	190	10,15	5
191555	25x28	190	11,00	5
191557	27x29	195	11,11	5
191560	30x32	210	11,31	5
191565	36x41	210	15,18	5

Juego de Llaves de Tubo estampadas en bolsa

194J

9 piezas



En bolsa de nylon

Code	Nº Piezas	P.V.P. unid. €	
191570	9	37,10	1

COMPOSICIÓN 6x7, 8x9, 10x11, 12x13, 14x15, 16x17, 18x19, 20x22 mm + volvedor

194J

14 piezas



Code	Nº Piezas	P.V.P. unid. €	
191575	14	76,43	1

COMPOSICIÓN 6x7, 8x9, 10x11, 12x13, 14x15, 16x17, 18x19, 20x22, 21x23, 24x27, 25x28, 30x32 mm + dos volvedores

Llaves de Pipa con agujero pasante

182

UNE 16594-2

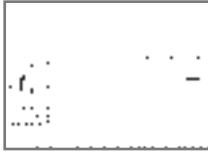

Permite atar tuercas sobre espárragos pasantes

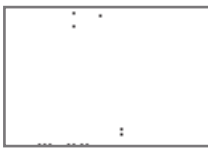

Permite utilizar barras para aprietes más fuertes

Agujero pasante



Terminación satinado mate

Bocas de 6 caras

Bocas pulidas

Llave especial para trabajos pesados de grandes esfuerzos

Code	Ø	L mm	P.V.P. unid. €	📦
175001	6	105	7,26	5
175002	7	105	7,49	5
175003	8	115	8,28	5
175004	9	122	8,77	5
175005	10	130	9,28	5
175006	11	136	9,35	5
175007	12	145	9,99	5
175008	13	152	10,73	5
175009	14	160	11,43	5
175010	15	170	12,55	5
175011	16	178	13,70	5
175012	17	187	14,43	5
175013	18	195	15,36	5
175014	19	205	15,78	5

Code	Ø	L mm	P.V.P. unid. €	📦
175015	20	212	17,22	5
175016	21	225	19,21	5
175017	22	225	20,56	5
175018	23	240	22,18	5
175019	24	250	22,50	1
175020	25	270	23,24	1
175021	26	270	29,58	1
175022	27	280	30,28	1
175023	28	290	31,52	1
175024	29	300	34,53	1
175025	30	310	39,30	1
175026	32	330	40,61	1
175027	36	355	54,80	1

Juego de Llaves de pipa

182JH

6 piezas

En soporte de plástico

Code	Nº Piezas	P.V.P. unid. €	📦
175030	6	69,82	1

COMPOSICIÓN 10, 11, 12, 13, 17, 19 mm



Llave de rueda 1/2"



Code	L mm/"	Ø mm	P.V.P. unid. €	
191492	300/12"	14	9,48	1

Llave de rueda 3/4"



Code	L mm/"	Ø mm	P.V.P. unid. €	
191494	300/12"	20	15,04	1
191496	450/18"	20	20,09	1

- Fabricado en Acero Cromo-Vanadio
- Mango moleteado para una manipulación más cómoda.
- Terminación satinado mate

Llaves en cruz 1/2"



Ø A	Ø B	Ø C	■ D
17	19	22	1/2"

Code	L ←mm→	P.V.P. unid. €	
191498	375	26,15	1

Llaves en cruz 3/4"



Ø A	Ø B	Ø C	■ D
24	27	32	3/4"

Code	L ←mm→	P.V.P. unid. €	
191499	625	77,44	1

- Templado a 45 ÷ 50 HRC
- Bocas pulidas
- Soldadura reforzada. Especialmente preparada para trabajos pesados.
- Terminación satinado mate.

Llave de Vaso articulada

111

UNE 16595



Vaso con boca de 12 caras
y aristas redondeadas

- Fabricada en acero Cr-V
- Bocas de 12 caras
- Terminación cromado
- Posibilidad de giro del vaso en 180°

Code	Hex	L mm	D1 mm	D2 mm	P.V.P. unid. €	
191652	6x7	182	9,5	11	10,71	2
191654	8x9	182	13	14	10,71	2
191656	10x11	198	15	16	11,03	2
191658	12x13	220	18	19	13,11	2
191660	14x15	240	20	22	14,73	2
191662	16x17	260	24	24	16,87	2
191664	18x19	275	26	26	19,60	2
191666	20x22	302	28	31	24,71	2
191668	21x23	307	29	33	25,79	2
191670	24x27	333	33	36,6	28,55	2
191672	30x32	349	39,7	41,7	32,81	2

Juego de Llaves de Vaso articuladas

111JN

8 Llaves



Code	Nº Piezas	P.V.P. unid. €	
191675	8	121,47	1

COMPOSICIÓN 6x7, 8x9, 10x11, 12x13, 14x15, 16x17, 18x19, 20x22 mm



Llaves magnéticas para bujías con mango en T

113

UNE 16533-2



Con cuadradillo
de 3/8" para accionar
con llave de carraca



- Fabricada en Acero al Cromo-Vanadio
- Presentación cromado
- Vaso magnético y hexagonal
- Fijación del vaso a diferentes ángulos

Code	Hex	L mm	S mm	D mm	P.V.P. unid. €	
191695	16	300	200	22	18,12	1
191697	21	300	200	28	18,82	1

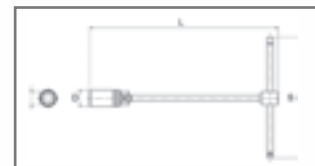
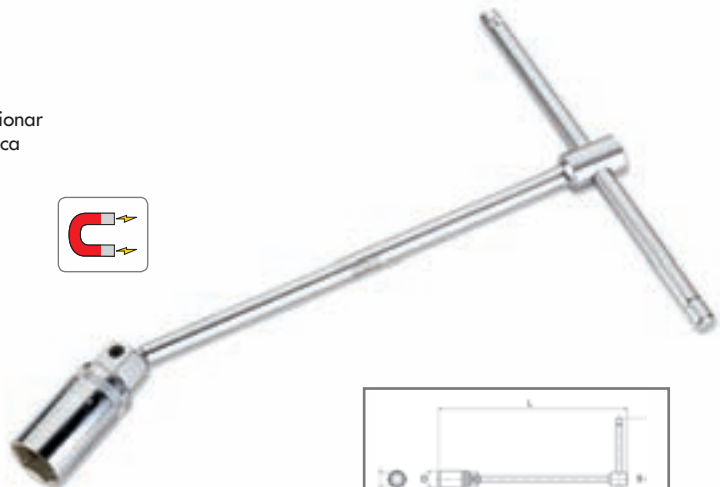

Llaves de Vaso con mango en T

114

UNE 16507-1
DIN 3112



- Vaso de 6 caras
- Fabricada en acero Cr-V
- Presentación: cromado
- Con articulación universal para poder ser inclinado a diferentes ángulos

Code	Hex	L mm	S mm	D mm	P.V.P. unid. €	Image
191682	8	390	200	12,5	16,66	1
191684	10	500	200	15	17,66	1
191686	12	500	200	17,5	17,66	1
191688	13	500	200	18	17,66	1
191690	17	500	200	24	18,50	1
191692	19	500	200	26	19,68	1

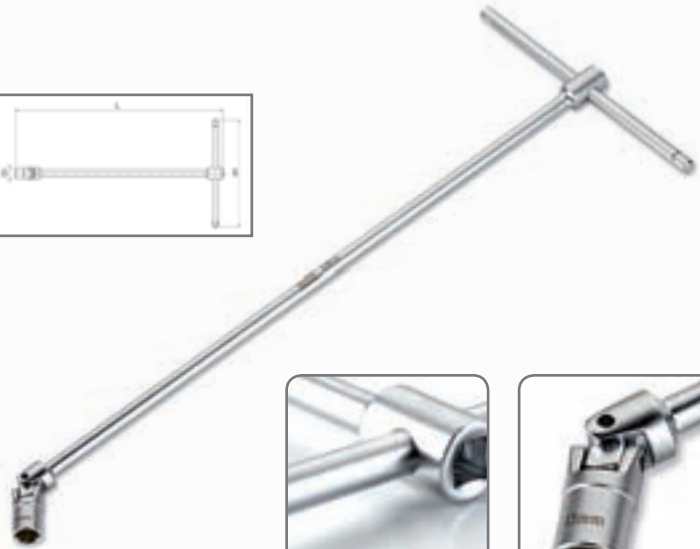

Con cuadradillo de 3/8" para accionar con llave de carraca



Articulación universal.

Llaves de cabina



En blister



Especialmente indicada para cabinas de agua, gas y electricidad.

Code	Medida mm	P.V.P. unid. €	Image
191990	60	12,12	6

- 5-6-8 mm
- 9 mm
- ⊕ Punta PH2
- △ 9 mm
- ⊙ Adapt. 1/4"
- ⊖ Plana 4,5 mm



Ambas llaves de cabina incluyen un adaptador de plástico para puntas



En blister



Especialmente indicada para cabinas de calefacción, aire acondicionado y saneamiento.

Code	Medida mm	P.V.P. unid. €	Image
191995	70	10,19	6

- 5-7-8 mm
- ◀ 4-10 mm
- ⊕ Punta PH2
- △ 10 mm
- ⊙ Adapt. 1/4"
- ⊖ Plana 4,5 mm

Llaves articuladas de pivote fijo

350RF



Code	Nº	Ø mm	L mm	P.V.P. unid. €	
145101	0	15-35	168	17,67	6
145102	1	35-50	202	19,25	6
145103	2	50-80	280	26,41	6
145104	3	80-120	345	34,22	4
145105	4	120-180	492	47,07	2

Llaves articuladas de pivote con tornillo

350R



Code	Nº	Ø mm	L mm	D mm	P.V.P. unid. €	
145106	0	15-35	168	3	18,87	6
145107	1	35-50	202	4	20,86	6
145108	2	50-80	280	5	27,17	6
145109	3	80-120	345	6	36,47	4
145110	4	120-180	492	8	48,81	2

• Acero al Cromo-Vanadio. Llave Articulada Forjada. Una misma llave es adecuada para diversos diámetros de tuerca. • Terminación: cromado satinado.

Tornillo de repuesto para Llaves articuladas

349R



Code	Nº	D mm	P.V.P. unid. €	
164021	0	3	2,26	6
164022	1	4	2,60	6
164023	2	5	3,22	6

Code	Nº	D mm	P.V.P. unid. €	
164024	3	6	3,55	6
164025	4	8	4,37	6

Llave de fleje para filtros

118



En blíster

- Terminación aluminio pintado rugoso
- Tornillo moleteado
- Cuerpo de aluminio
- Fleje de acero

Code	Ø Filtro	P.V.P. unid. €	
198850	65-110	11,03	1
198855	110-155	12,90	1

REPUESTO DE FLEJE

Code	Para llave	P.V.P. unid. €	
198851	198850 (65-110 mm)	2,06	1
198856	198855 (110-155 mm)	2,28	1



Llave Ajustable con mango antideslizante

136

UNE 16532
DIN 3117



En doble blíster

La apertura de las bocas excede en más del 18% las normas DIN

Terminación satinado mate. Cabeza pulida

Especial diseño que disminuye su peso en más de un 10%.
Muy ligera

Agujero en el mango para colgar

Mango con forma ergonómica recubierto con material antideslizante

Cabeza graduada para ajustes rápidos

Fabricada en Acero Cromo-Vanadio

Especial diseño de las bocas interiores para utilizar con tornillos dañados



Code	L mm	C mm	D mm	P.V.P. unid. €	
172260	150	24	18	15,20	6
172261	200	29	24	17,66	6
172262	250	34	28	21,60	6
172263	300	39	33	28,51	6
172264	380	50	48	48,32	1

Llave Ajustable de moleta lateral

137

UNE 16532
DIN 3117



Presentación de las bocas pulidas

Perfil más fino de la cabeza para acceder a lugares reducidos

Forma del mango redondeada y más ancha para un uso más confortable

Cabeza milimetrada por ambos lados para ajustes rápidos



Máxima apertura de la boca excede las normas DIN

Code	L mm	C mm	C (DIN) mm
172270	150	23,9	19
172271	200	28,6	24
172272	250	32,8	28
172273	300	38,1	34
172274	400	50	43

15°

Ángulo de la cabeza de 15° para un manejo más ergonómico y preciso de la llave

Sistema de apertura mediante moleta lateral

Code	L mm	C mm	D mm	P.V.P. unid. €	
172270	150	23,9	23	17,97	6
172271	200	28,6	26,5	19,90	6
172272	250	32,8	31	24,60	6
172273	300	38,1	39	31,46	6
172274	400	50	48	50,99	4
172275	500	55	65	86,90	2



Llave Ajustable de apertura extra

138

En blíster individual



Cabeza milimetrada



Terminación pavonado con bocas pulidas

Fabricada en Acero Cromo Vanadio

Agujero para colgar

Mango antideslizante con forma ergonómica

Diseño muy compacto. Llave muy ligera para un manejo fácil y ergonómico.

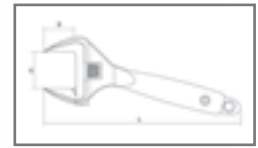

COMPARATIVA APERTURA Y PROFUNDIDAD DE BOCAS

Code	C	C (DIN)	D	D (DIN)
172280	34	19	28,9	17,5
172281	38	24	32,4	22
172282	50	28	41	26

Valores de la llave ajustable de apertura extra comparados con los valores marcados por la norma DIN

Code	L mm	C mm	D mm	P.V.P. unid. €	
172280	150	34	28,9	16,51	6
172281	200	38	32,4	18,96	6
172282	250	50	41	23,43	5

- 1 Perfil de las bocas muy fino para utilizar en lugares de difícil acceso. Pares de torsión muy superiores a la norma DIN.
- 2 Bocas muy profundas, altura de la boca aproximadamente un 30% mayor que la norma DIN
- 3 Ángulo de 15° que permite una alineación entre la llave y la tuerca para aprietes muy rápidos, precisos y ergonómicos.
- 4 Llave ajustable de bocas de gran apertura. Aproximadamente un 55% mayor que la norma DIN

Llave Ajustable de moleta central

135

UNE 16532
DIN 3117

- Fabricada en Acero al Cromo-Vanadio.
- Apertura máxima de las bocas y profundidad exceden de las normas DIN.
- Cabeza graduada para preajustes.
- Terminación en cromado brillante.

Code	L mm	C mm	D mm	P.V.P. unid. €	
172250	150	20	18	12,50	6
172251	200	24	25	14,49	6
172252	250	29	29	18,13	6
172253	300	34	32	23,38	6
172254	380	43	44	42,23	2
172255	450	53	53	63,79	2
172256	600	70	62	118,55	1

Llave Ajustable serie corta

139



- Fabricada en Acero al Cr-V
- Mango bimaterial y ergonómico.
- Cabeza graduada.
- Apertura y altura de bocas superior a normas DIN.

Code	L mm	C mm	D mm	P.V.P. unid. €	
172290	150	20	19	12,97	6
172291	200	24,5	26,5	14,76	6

Llaves Dinamométricas con cierre rápido

UNE 26789
DIN 6789



Escala graduada para la regulación del par de apriete deseado (N.m)

Cierre rápido de seguridad

En caja de plástico

Número de serie individual

Rearme automático una vez alcanzado el par regulado

Cada llave cuenta con un certificado de calibración individual que se suministra con la llave



Llave reversible

Señal sonora al alcanzar el par de apriete regulado

Precisión del par de apriete del $\pm 4\%$

LLAVES DINAMOMÉTRICAS DE CIERRE RÁPIDO

Code	Ref.	Tamaño \square	Capacidad N/m	Kg/m	P.V.P. unid. €	
192920	1492 SP	1/4"	4-20	0.4-2	107,10	1
192930	3892 SP	3/8"	20-100	2-10	121,61	1
192900	1292 SP	1/2"	40-200	4-20	134,10	1
192910	1292-4 SP	1/2"	60-340	6-34	177,05	1
192940	3492 SP	3/4"	80-400	8-40	346,74	1
192945	3492 SP	3/4"	150-800	15-80	506,08	1

Llaves Dinamométricas con tuerca



LLAVES DINAMOMÉTRICAS

Code	Ref.	Tamaño \square	Capacidad N/m	Kg/m	P.V.P. unid. €	
192820	1492	1/4"	5-25	0.5-2.5	76,22	1
192830	3892	3/8"	10-110	1-11	91,85	1
192800	1292	1/2"	42-210	4.2-21	97,03	1
192810	1292-4	1/2"	50-350	5-35	153,85	1
192840	3492	3/4"	80-400	8-40	261,77	1

*Características idénticas a la anterior salvo el cierre rápido

